

# Profile für James Hardie Fassadenbekleidungen

1.1	Würfeleckprofile abgekantet
1.2	Würfeleckprofile stranggepresst,
1.3	Würfelsturzprofile abgekantet / Eckverbinder
1.4	Inneneckprofile stranggepresst
1.5	Leibungsprofile Nr. 1 stranggepresst
1.6	Spezialsturzprofile Nr. 1 stranggepresst
1.7	L Æ Profile Chromstahl / L Æ Profile Alu
1.7	Z Æ Profile
1.8	U Æ Profile
1.8	Lüftungsprofile

## Bestelldaten:

Glaromat AG | Im Fennen 3 | 8867 Niederurnen

E-Mail: [info@glaromat.ch](mailto:info@glaromat.ch)

Tel. 055 617 21 30

Fax 055 617 21 38







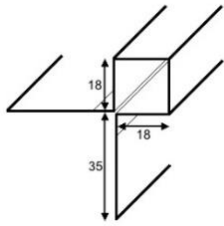

[www.glaromat.ch](http://www.glaromat.ch)

## Würfeleckprofile abgekantet

**Alu 0.8 mm**

Länge 2800 mm



Art. Nr.	Ausführung	Steghöhe mm	Preis CHF/m1
EBAL18R	 Roh	18 / 18	<b>7.70</b>
EBAL18E	 Eloxiert	18 / 18	<b>10.65</b>
EBAL18JHMGRAU	 Metallgrau	18 / 18	<b>10.65</b>
EBAL18JHKGRAU	 Kieselgrau	18 / 18	<b>10.65</b>
EBAL18JHSGRAU	 Stahlgrau	18 / 18	<b>10.65</b>
EBAL18JHBRAUN	 Kastanienbraun	18 / 18	<b>10.65</b>
EBAL18JHNGRAU	 Nebelgrau	18 / 18	<b>10.65</b>
EBAL18JHWEISS	 Schneeweiss	18 / 18	<b>10.65</b>
EBAL18	 Beschichtet	18 / 18	<b>10.65</b>

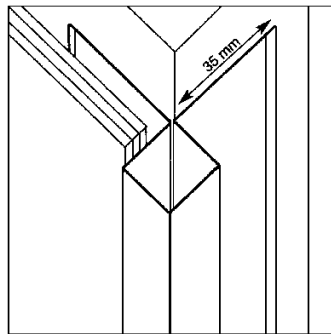

Farbzuschlag für Sonderfarben 80.00CHF pro Farbe







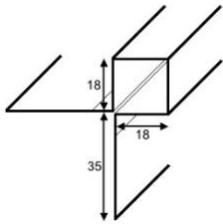

## Würfeleckprofile stranggepresst

### Alu 0.8 mm

Länge 2800 mm

mit Verbindungszapfen











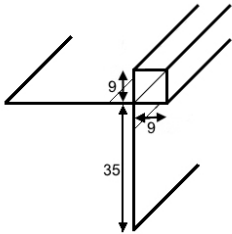

Art. Nr.	Ausführung	Steghöhe mm	Preis CHF/m1
EBAL18ZR	 Roh	18 / 18	7.70
EBAL18ZE	 Eloxiert	18 / 18	10.65
EBAL18ZJHMGRAU	 Metallgrau	18 / 18	10.65
EBAL18ZJHKGRAU	 Kieselgrau	18 / 18	10.65
EBAL18ZJHSGRAU	 Stahlgrau	18 / 18	10.65
EBAL18ZJHBRAUN	 Kastanienbraun	18 / 18	10.65
EBAL18ZJHNGRAU	 Nebelgrau	18 / 18	10.65
EBAL18ZJHWEISS	 Schneeweiss	18 / 18	10.65
EBAL18Z	 Beschichtet	18 / 18	10.65

### Alu 0.8 mm

Länge 2800 mm

ohne Verbindungszapfen

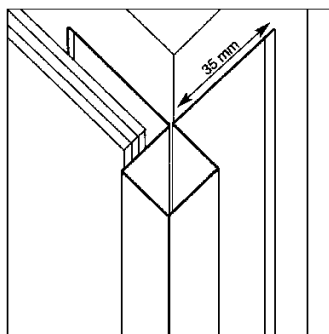

Art. Nr.	Ausführung	Steghöhe mm	Preis CHF/m1
EBAL10R	 Roh	9 / 9	9.40
EBAL10E	 Eloxiert	9 / 9	13.60
EBAL10JHMGRAU	 Metallgrau	9 / 9	13.60
EBAL10JHKGRAU	 Kieselgrau	9 / 9	13.60
EBAL10JHSGRAU	 Stahlgrau	9 / 9	13.60
EBAL10JHBRAUN	 Kastanienbraun	9 / 9	13.60
EBAL10JHNGRAU	 Nebelgrau	9 / 9	13.60
EBAL10JHWEISS	 Schneeweiss	9 / 9	13.60
EBAL10	 Beschichtet	9 / 9	13.60

 Farbzuschlag für Sonderfarben 80.00CHF pro Farbe



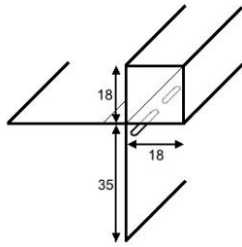





## Würfelsturzprofile abgekantet mit Lüftungsschlitzen



**Alu 0.8 mm**

Länge 2800 mm

ohne Verbindungszapfen



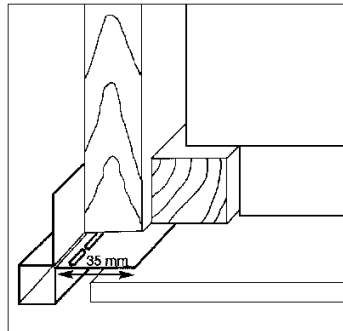





Art. Nr.	Ausführung	Steghöhe mm	Preis CHF/m1
SBAL18R	 Roh	18 / 18	10.85
SBAL18E	 Eloxier	18 / 18	14.20
SBAL18JHMGRAU	 Metallgrau	18 / 18	14.20
SBAL18JHKGRAU	 Kieselgrau	18 / 18	14.20
SBAL18JHSGRAU	 Stahlgrau	18 / 18	14.20
SBAL18JHBRAUN	 Kastanienbraun	18 / 18	14.20
SBAL18JHNGRAU	 Nebelgrau	18 / 18	14.20
SBAL18JHWEISS	 Schneeweiss	18 / 18	14.20
SBAL18	 Beschichtet	18 / 18	14.20



## Eckverbindungen



**Alu 0.8 mm**

Art. Nr.	Ausführung	Steghöhe mm	Preis CHF/Stk
VERB18R	 Roh	18 / 18	7.70
VERB18E	 Eloxier	18 / 18	8.40
VERB18JHMGRAU	 Metallgrau	18 / 18	8.40
VERB18JHKGRAU	 Kieselgrau	18 / 18	8.40
VERB18JHSGRAU	 Stahlgrau	18 / 18	8.40
VERB18JHBRAUN	 Kastanienbraun	18 / 18	8.40
VERB18JHNGRAU	 Nebelgrau	18 / 18	8.40
VERB18JHWEISS	 Schneeweiss	18 / 18	8.40
VERB18	 Beschichtet	18 / 18	8.40







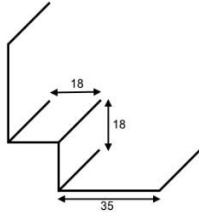



Farbzuschlag für Sonderfarben 80.00CHF pro Farbe

## Inneneckprofile stranggepresst



### Alu 0.8 mm





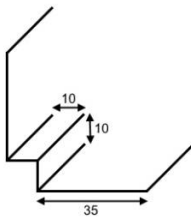



Länge 2800 mm

Art. Nr.	Ausführung	Steghöhe mm	Preis CHF/m1
IEBAL18R	 Roh	18 / 18	7.70
IEBAL18E	 Eloxiert	18 / 18	10.65
IEBAL18JHMGRAU	 Metallgrau	18 / 18	10.65
IEBAL18JHKGRAU	 Kieselgrau	18 / 18	10.65
IEBAL18JHSGRAU	 Stahlgrau	18 / 18	10.65
IEBAL18JHBRAUN	 Kastanienbraun	18 / 18	10.65
IEBAL18JHNGRAU	 Nebelgrau	18 / 18	10.65
IEBAL18JHWEISS	 Schneeweiss	18 / 18	10.65
IEBAL18	 Beschichtet	18 / 18	10.65



### Alu 0.8 mm

Länge 2800 mm

Art. Nr.	Ausführung	Steghöhe mm	Preis CHF/m1
IEBAL10R	 Roh	10 / 10	7.70
IEBAL10E	 Eloxiert	10 / 10	10.65
IEBAL10JHMGRAU	 Metallgrau	10 / 10	10.65
IEBAL10JHKGRAU	 Kieselgrau	10 / 10	10.65
IEBAL10JHSGRAU	 Stahlgrau	10 / 10	10.65
IEBAL10JHBRAUN	 Kastanienbraun	10 / 10	10.65
IEBAL10JHNGRAU	 Nebelgrau	10 / 10	10.65
IEBAL10JHWEISS	 Schneeweiss	10 / 10	10.65
IEBAL10	 Beschichtet	10 / 10	10.65







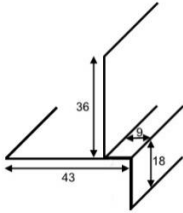

 Farbzuschlag für Sonderfarben 80.00CHF pro Farbe

## Leibungsprofile Nr. 1 stranggepresst

**Alu 0.8 mm**

Länge 2800 mm









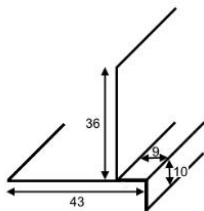

Art. Nr.	Ausführung	Steghöhe mm	Preis CHF/m1
LEBAL18R	 Roh	9 / 18	7.70
LEBAL18E	 Eloxiert	9 / 18	10.65
LEBAL18JHMGRAU	 Metallgrau	9 / 18	10.65
LEBAL18JHKGRAU	 Kieselgrau	9 / 18	10.65
LEBAL18JHSGRAU	 Stahlgrau	9 / 18	10.65
LEBAL18JHBRAUN	 Kastanienbraun	9 / 18	10.65
LEBAL18JHNGRAU	 Nebelgrau	9 / 18	10.65
LEBAL18JHWEISS	 Schneeweiss	9 / 18	10.65
LEBAL18	 Beschichtet	9 / 18	10.65

**Alu 0.8 mm**

Länge 2800 mm



Art. Nr.	Ausführung	Steghöhe mm	Preis CHF/m1
LEBAL10R	 Roh	9 / 10	7.70
LEBAL10E	 Eloxiert	9 / 10	10.65
LEBAL10JHMGRAU	 Metallgrau	9 / 10	10.65
LEBAL10JHKGRAU	 Kieselgrau	9 / 10	10.65
LEBAL10JHSGRAU	 Stahlgrau	9 / 10	10.65
LEBAL10JHBRAUN	 Kastanienbraun	9 / 10	10.65
LEBAL10JHNGRAU	 Nebelgrau	9 / 10	10.65
LEBAL10JHWEISS	 Schneeweiss	9 / 10	10.65
LEBAL10	 Beschichtet	9 / 10	10.65

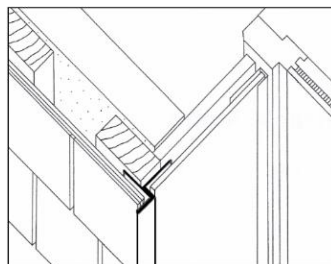









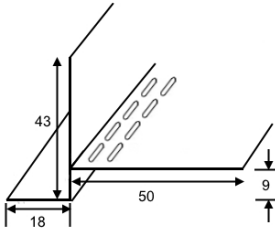

 Farbzuschlag für Sonderfarben 80.00CHF pro Farbe

## Spezialsturzprofile Nr. 1 stranggepresst

**Alu 0.8 mm**

Länge 2800 mm









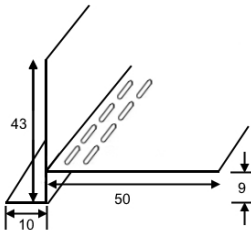

Art. Nr.	Ausführung	Steghöhe mm	Preis CHF/m1
SBALS18R	 Roh	9 / 18	<b>12.80</b>
SBALS18E	 Eloxiert	9 / 18	<b>16.70</b>
SBALS18JHMGRau	 Metallgrau	9 / 18	<b>16.70</b>
SBALS18JHKGRau	 Kieselgrau	9 / 18	<b>16.70</b>
SBALS18JHSGRau	 Stahlgrau	9 / 18	<b>16.70</b>
SBALS18JHBraun	 Kastanienbraun	9 / 18	<b>16.70</b>
SBALS18JHNGRau	 Nebelgrau	9 / 18	<b>16.70</b>
SBALS18JHWEISS	 Schneeweiss	9 / 18	<b>16.70</b>
SBALS18	 Beschichtet	9 / 18	<b>16.70</b>

**Alu 0.8 mm**

Länge 2800 mm



Art. Nr.	Ausführung	Steghöhe mm	Preis CHF/m1
SBALS10R	 Roh	9 / 10	<b>12.80</b>
SBALS10E	 Eloxiert	9 / 10	<b>16.70</b>
SBALS10JHMGRau	 Metallgrau	9 / 10	<b>16.70</b>
SBALS10JHKGRau	 Kieselgrau	9 / 10	<b>16.70</b>
SBALS10JHSGRau	 Stahlgrau	9 / 10	<b>16.70</b>
SBALS10JHBraun	 Kastanienbraun	9 / 10	<b>16.70</b>
SBALS10JHNGRau	 Nebelgrau	9 / 10	<b>16.70</b>
SBALS10JHWEISS	 Schneeweiss	9 / 10	<b>16.70</b>
SBALS10	 Beschichtet	9 / 10	<b>16.70</b>

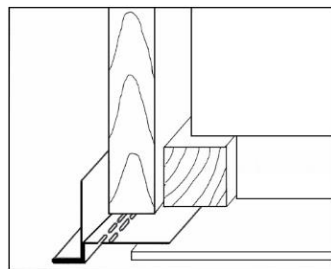





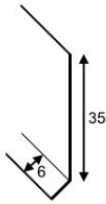



 Farbzuschlag für Sonderfarben 80.00CHF pro Farbe

## L Æ Profile



### Chromstahl 0.5 mm

Längen 2000 / 2500 / 3000 / 3040 mm

Art. Nr.	Ausführung	Format mm	Preis CHF/m1
FPVCRL	 Roh	6 / 35	4.40
FPVCEBS	 Eloxiert	6 / 35	6.25
FPVCEBJHMGRAU	 Metallgrau	6 / 35	7.50
FPVCEBJHKGRAU	 Kieselgrau	6 / 35	7.50
FPVCEBJHSGRAU	 Stahlgrau	6 / 35	7.50
FPVCEBJHBRAUN	 Kastanienbraun	6 / 35	7.50
FPVCEBJHNGRAU	 Nebelgrau	6 / 35	7.50
FPVCEBJHWEISS	 Schneeweiss	6 / 35	7.50
FPVCEB	 Beschichtet	6 / 35	7.50

### Alu 0.5 mm

Längen 2500 / 3000 / 3040 mm





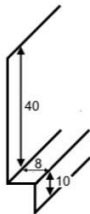



Art. Nr.	Ausführung	Format mm	Preis CHF/m1
FPALEBSL	 Schwarz matt	6 / 35	4.30

## Z Æ Profile



### Alu 0.8 mm

Länge 3000 mm

Art. Nr.	Ausführung	Format mm	Preis CHF/m1
FPHZR	 Roh	40 / 8 / 10	6.65
FPHZE	 Eloxiert	40 / 8 / 10	11.15
FPHZSJHMGRAU	 Metallgrau	40 / 8 / 10	11.15
FPHZSJHKGRAU	 Kieselgrau	40 / 8 / 10	11.15
FPHZSJHSGRAU	 Stahlgrau	40 / 8 / 10	11.15
FPHZSJHBRAUN	 Kastanienbraun	40 / 8 / 10	11.15
FPHZSJHNGRAU	 Nebelgrau	40 / 8 / 10	11.15
FPHZSJHWEISS	 Schneeweiss	40 / 8 / 10	11.15
FPHZS	 Beschichtet	40 / 8 / 10	11.15









 Farbzuschlag für Sonderfarben 80.00CHF pro Farbe



## U Æ Profile Alu

**Alu 0.8 mm**
**stranggepresst**
**U Æ Profil Längen**

2000 mm / 2500 mm / 2800 mm / 3000 mm

Art. Nr	Ausführung	Abwicklung mm	Preis CHF/m1
UPALR	 Roh	35 / 9 / 15	<b>8.20</b>
UPALE	 Eloxiert	35 / 9 / 15	<b>10.45</b>
UPALJHMGRAU	 Metallgrau	35 / 9 / 15	<b>10.45</b>
UPALJHKGRAU	 Kieselgrau	35 / 9 / 15	<b>10.45</b>
UPALJHSGRAU	 Stahlgrau	35 / 9 / 15	<b>10.45</b>
UPALJHBRAUN	 Kastanienbraun	35 / 9 / 15	<b>10.45</b>
UPALJHNGRAU	 Nebelgrau	35 / 9 / 15	<b>10.45</b>
UPALJHWEISS	 Schneeweiss	35 / 9 / 15	<b>10.45</b>
UPAL	 Beschichtet	35 / 9 / 15	<b>10.45</b>

## Lüftungsprofile Alu

**Alu roh**

Länge 2500 mm



Art. Nr.	Dimension	Lochanteil	Preis CHF/m1
LPAL2730	<b>27 / 30 mm</b>	34%   31%	<b>4.20</b>
LPAL3030	<b>30 / 30 mm</b>	31%   31%	<b>4.20</b>
LPAL3040	<b>30 / 40 mm</b>	31%   35%	<b>4.20</b>
LPAL2550	<b>25 / 50 mm</b>	28%   37%	<b>4.30</b>
LPAL2750	<b>27 / 50 mm</b>	34%   37%	<b>4.30</b>
LPAL3050	<b>30 / 50 mm</b>	31%   37%	<b>4.30</b>
LPAL3060	<b>30 / 60 mm</b>	35%	<b>4.60</b>
LPAL3070	<b>30 / 70 mm</b>	36%	<b>4.85</b>
LPAL3090	<b>30 / 90 mm</b>	38%	<b>6.25</b>
LPAL40100	<b>30 / 100 mm</b>	39%	<b>6.85</b>
LPAL40120	<b>30 / 120 mm</b>	39%	<b>8.50</b>



- ab 30 / 60 mm nur ein Schenkel gelocht
- Andere Abmessungen auf Anfrage



Farbzuschlag für Sonderfarben 80.00CHF pro Farbe



Kundenspezifisch abgekantete Profile auf Anfrage erhältlich